

# VVC4

## Voltage Controlled Crystal Oscillator



The VVC4 Voltage Controlled Crystal Oscillator

### Features

- Vectron's Smallest VCXO, 5.0 X 3.2 X 1.2 mm
- High Frequencies to 77.760 MHz
- 5.0 or 3.3 V operation
- Linearity  $\leq 10\%$
- Tri-State Output for testing
- Low jitter < 1ps RMS 12 KHz to 20 MHz
- CMOS output
- 0/70 or -40/85 °C temperature range
- Hermetically sealed ceramic SMD package

Product is compliant to RoHS directive  and fully compatible with lead free assembly

### Applications

- Home Gateway
- WIMAX
- xDSL/PCMCIA cards
- Digital Video

### Description

Vectron's VVC4 Voltage Controlled Crystal Oscillator (VCXO) is a quartz stabilized square wave generator with a CMOS output and is tested at CMOS and TTL (5.0 volt operation) logic levels.

The VVC4 is the smallest available VCXO making it ideally suitable for applications where size is limited but performance is required.

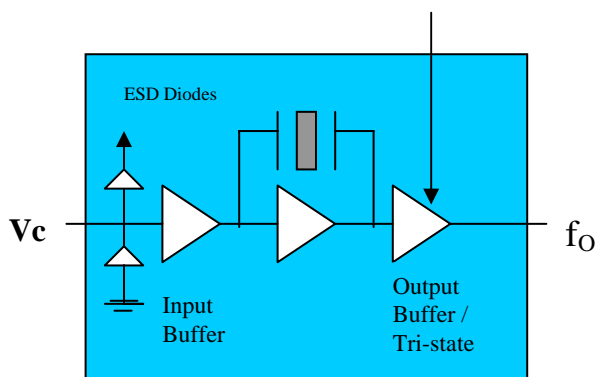

# VVC4 Voltage Controlled Crystal Oscillator

## Performance Characteristics

Parameter	Symbol	Min	Typical	Maximum	Units
Frequency	$f_O$	3.2500		77.7600	MHz
Supply Voltage <sup>1</sup> (+3.3 V) (+5.0 V)	$V_{DD}$	2.97 4.5	3.3 5.0	3.63 5.5	V
Supply Current	$I_{DD}$		8	15	mA
Output Logic Levels Output Logic High <sup>2</sup> Output Logic Low <sup>2</sup>	$V_{OH}$ $V_{OL}$	0.9* $V_{DD}$		0.1 $V_{DD}$	V V
Rise and Fall Time <sup>2</sup> <24 MHz >24 MHz	$t_R / t_F$			10 6	ns ns
Tristate Output Enabled Output Disabled	$V_{IN}$ $V_{IL}$	2.5		0.7	V V
Symmetry or Duty Cycle <sup>3</sup> (ordering option)	SYM	40	50	60	%
Operating temperature (ordering option)		0/70 or -40/85			°C
Test Conditions for APR (+5V option)	$V_C$	0.5		4.5	V
Test Conditions for APR (+3.3V option)	$V_C$	0.3		3.0	V
Absolute Pull Range (ordering option)	APR	±50 ±80 ±100			ppm
Gain Transfer		Positive			ppm/V
Input Impedance			160		KOhm
Control Voltage Bandwidth (-3dB)	BW	10			kHz
Phase Noise 10 Hz Offset 100 Hz Offset 1 KHz Offset 10 KHz Offset 100 KHz Offset 1 MHz Offset			-65 -95 -125 -140 -145 -150		dBc/Hz dBc/Hz dBc/Hz dBc/Hz dBc/Hz dBc/Hz
Package Size		5.0 x 3.2 x 1.2			mm

1. A 0.01 $\mu$ F and a 0.1 $\mu$ F capacitor should be located as close to the supply as possible (to ground) is recommended.
2. Figure 1 defines these parameters. Figure 2 illustrates the equivalent five gate TTL load and operating conditions under which these parameters are tested and specified.
3. Symmetry is defined as (ON TIME/PERIOD with  $V_s = 1.4$  V for TTL and  $V_s = 2.5$  V for CMOS, 5 volt operation, and  $V_s = 1.65$  V for 3.3 Volt operation.

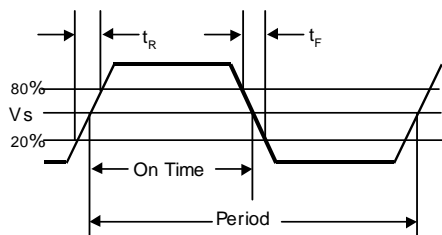

Figure 1. Output Waveform

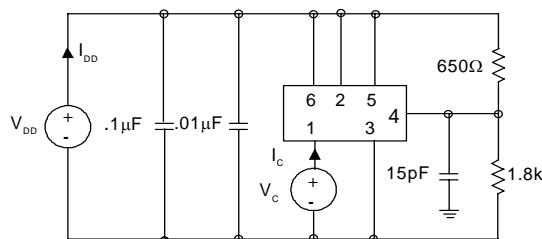
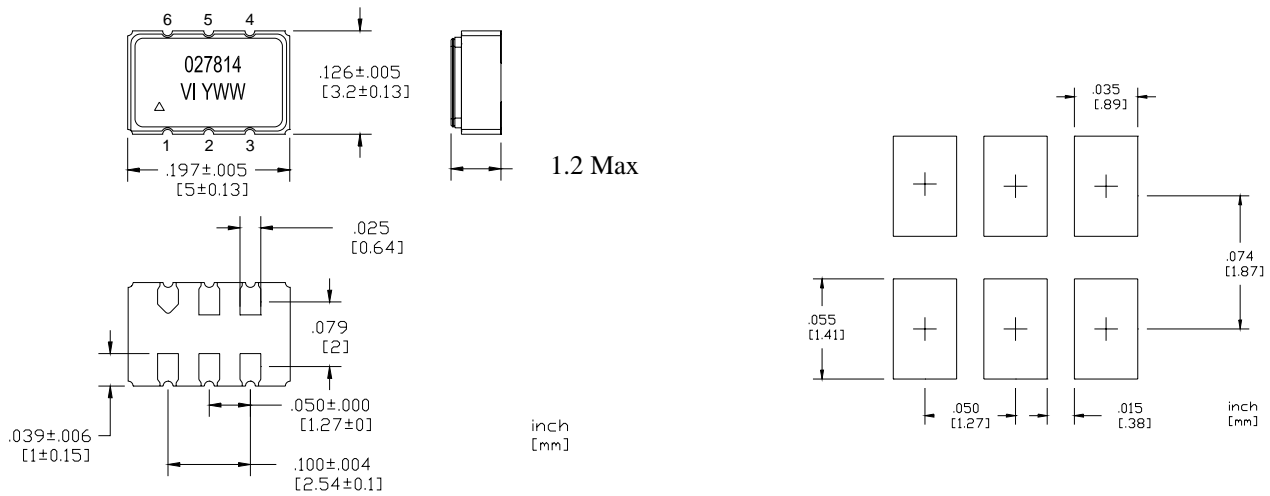

Figure 2. Typical Output Test Conditions (25±5°C)

# VVC4 Voltage Controlled Crystal Oscillator

## Outline Diagram, Pad Layout and Pin Out



Pin #	Symbol	Function
1	V <sub>C</sub>	Control Voltage
2	Tri-state	Logic low disables output Logic high or no connection enables output waveform
3	GND	Ground
4	f <sub>o</sub>	Output Frequency
5	CMOS/TTL	Logic low for CMOS optimized symmetry Logic high or no connection for TTL optimized symmetry
6	V <sub>DD</sub>	Supply Voltage

## Tape and Reel

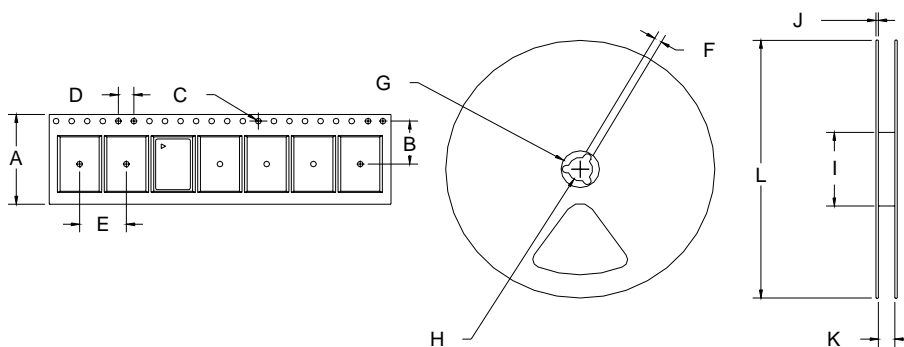

Tape and Reel Dimensions (mm)													
Tape Dimensions						Reel Dimensions						# Per Reel	
Product	A	B	C	D	E	F	G	H	I	J	K	L	Reel
VVC4	12	5.5	1.5	4	8	1.78	20.6	13	55	6	12.4	178	500

## VVC4 Voltage Controlled Crystal Oscillator

### Absolute Maximum Ratings

Stresses in excess of the absolute maximum ratings can permanently damage the device. Functional operation is not implied at these or any other conditions in excess of conditions represented in the operational sections of this data sheet. Exposure to absolute maximum ratings for extended periods may adversely affect device reliability.

**Table 2. Absolute Maximum Ratings**

Parameter	Symbol	Ratings	Unit
Power Supply	$V_{DD}$	6	Vdc
Storage Temperature	Tstorage	-55/125	°C
Voltage Control Range	$V_C$	0 to $V_{DD}$	V

### Reliability

The VVC4 is capable of meeting the following qualification tests.

**Table 3. Environmental Compliance**

Parameter	Conditions
Mechanical Shock	MIL-STD-883 Method 2002
Mechanical Vibration	MIL-STD-883 Method 2007
Solderability	MIL-STD-883 Method 2003
Gross and Fine Leak	MIL-STD-883 Method 1014
Resistance to Solvents	MIL-STD-883 Method 2016
Moisture Sensitivity Level	1

### Handling Precautions

Although ESD protection circuitry has been designed into the the VVC4, proper precautions should be taken when handling and mounting. VI employs a Human Body Model and a Charged-Device Model (CDM) for ESD susceptibility testing and design protection evaluation. ESD thresholds are dependent on the circuit parameters used to define the model. Although no industry wide standard has been adopted for the CDM, a standard HBM of resistance = 1.5kohms and capacitance = 100pF is widely used and therefore can be used for comparison purposes.

**Table 4. ESD Ratings**

Model	Minimum	Conditions
Human Body Model	1500	MIL-STD-883 Method 3115
Charged Device Model	1000	JESD 22-C101

The VVC4 is qualified to meet the JEDEC standard for Pb-Free assembly. The temperatures and time intervals listed are based on the Pb-Free small body requirements and parameters are listed in the table below. The contact pads are gold over nickel so lower IR reflow temperatures such as 220°C can be used (device is backwards compatible with a lead solder assembly).

The VVC4 is hermetically sealed so an aqueous wash is not an issue.

**Table 5. Reflow Profile (IPC/JEDEC J-STD-020)**

Parameter	Symbol	Value
PreHeat Time	$t_S$	60 sec Min, 180 sec Max
Ramp Up	$R_{UP}$	3 °C/sec Max
Time Above 217 °C	$t_L$	60 sec Min, 150 sec Max
Time To Peak Temperature	$t_{AMB-P}$	480 sec Max
Time At 260 °C	$t_P$	20 sec Min, 40 sec Max
Ramp Down	$R_{DN}$	6 °C/sec Max

# VVC4 Voltage Controlled Crystal Oscillator

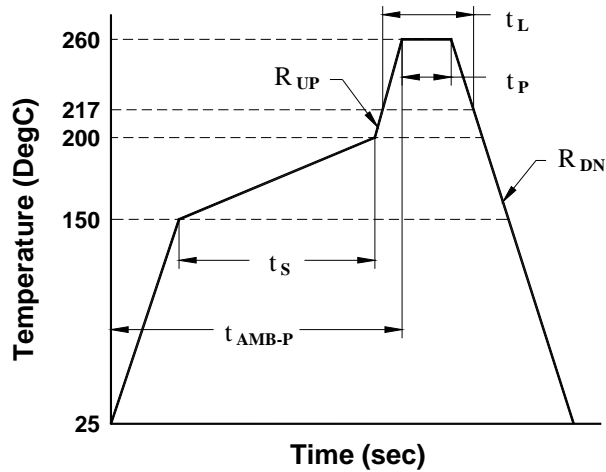

Standard Frequencies (MHz)				
3.600	4.096	8.192	10.000	12.960
13.500	16.384	19.440	27.000	28.375
32.768	34.560	38.785	44.736	51.840
74.1758	74.250	77.760		

Other frequencies may be available upon request

## Ordering Information

### VVC4-BGD-xxMxxx

**Product Family**  
VV = VCXO

**Package**  
5x3.2x1.2

**Power Supply/Linearity**  
A: 5.0V, 20% Linearity  
B: 3.3V, 20% Linearity  
C: 5.0V, 10% Linearity  
D: 3.3V, 10% Linearity

**Frequency**  
ex. 44M736 = 44.736 MHz

**Temperature Range**  
B: 0 to +70°C  
D: -40 to +85°C

**Absolute Pull Range**  
G: ±50 ppm APR  
N: ±80 ppm APR  
H: ±100 ppm APR

## For Additional Information, Please Contact:



USA: Vectron International, 267 Lowell Rd, Hudson, NH 03051 .....  
EUROPE: .....  
ASIA: .....

Tel: 1-88-VECTRON-1  
Tel: 49 (0) 7268 8010  
Tel: 86 21 5048 0777

Fax: 1-888-FAX-VECTRON  
Fax: 49 (0) 7268 801281  
Fax: 86 21 5048 1881

Vectron International reserves the right to make changes to the product(s) and/or information contained herein without notice. No liability is assumed as a result of their use or application. No rights under any patent accompany the sale of any such product(s) or information.