

VI TELEFILTER

Filter specification

TFS 76E

1/5

Measurement condition

Ambient temperature:	23	°C
Input power level:	0	dBm
Terminating impedance: *		
Input:	220 Ω	-40 pF
Output:	270 Ω	-31 pF

Characteristics

Remark:

The reference level for the relative attenuation a_{rel} of the TFS 76E is the minimum of the pass band attenuation a_{min} . The minimum of the pass band attenuation a_{min} is defined as the insertion loss a_e . The nominal frequency f_N is fixed at 76,5. The values for relative attenuation are guaranteed at ambient temperature. The frequency shift of the filter over temperature defined by the temperature coefficient of frequency TC_f is not included in the production tolerance scheme.

D a t a			typ. value		tolerance / limit	
Insertion loss (reference level)	a_e		10,4	dB	max.	12,5 dB
Nominal frequency	f_N					76,5 MHz
Pass band	PB		14,2	MHz	f_N	± 6,25 MHz
Pass band ripple	p-p		0,8	dB	max.	1,8 dB
Bandwidth						
1,4 dB			13,9	MHz		
3 dB			14,7	MHz		
15 dB			17,4	MHz	max.	17,6 MHz
30 dB			18,7	MHz	max.	18,9 MHz
Mean relative attenuation	a_{rel}					
86,47 MHz ...	91,53 MHz		47	dB	min.	38 dB
Relative attenuation	a_{rel}					
70,25 MHz ...	82,75 MHz		0,8	dB	max.	1,8 dB
50,00 MHz ...	64,44 MHz		50	dB	min.	44,0 dB
64,44 MHz ...	66,94 MHz		48	dB	min.	36,0 dB
86,47 MHz ...	91,53 MHz		30	dB	min.	26,0 dB
91,53 MHz ...	95,21 MHz		44	dB	min.	40,0 dB
95,21 MHz ...	100,00 MHz		48	dB	min.	40,0 dB
Group delay ripple in PB	p-p		75	ns		-
Input power level			-		max.	10 dBm
Permissible DC voltage			-		max.	0 V
Operating temperature range	OTR		-			-40 °C ... + 85 °C
Storage temperature range			-			-40 °C ... + 85 °C
Temperature coefficient of frequency	TC_f **		-89	ppm/K		-

*) The terminating impedances depend on parasitics and q-values of matching elements and the board used, and are to be understood as reference values only. Should there be additional questions do not hesitate to ask for an application note or contact our design team.

***) $\Delta f_c(\text{Hz}) = TC_f(\text{ppm/K}) \times (T - T_o) \times f_{T_o}(\text{MHz})$.

Generated:

Checked / Approved:

Tele Filter GmbH
Potsdamer Straße 18
D 14 513 TELTOW / Germany
Tel: (+49) 3328 4784-0 / Fax: (+49) 3328 4784-30
E-Mail: tft@telefilter.com

VI TELEFILTER reserves the right to make changes to the product(s) and/or information contained herein without notice. No liability is assumed as a result of their use or application. No rights under any patent accompany the sale of any such product(s) or information.

Filter characteristic

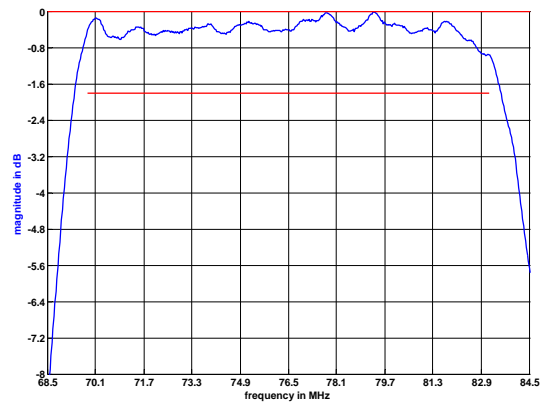
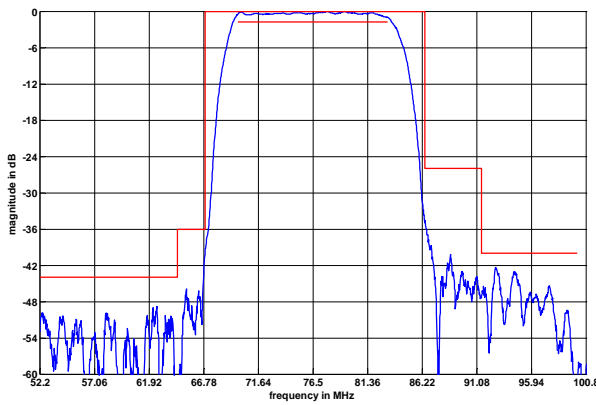

Construction and pin connection

(All dimensions in mm)

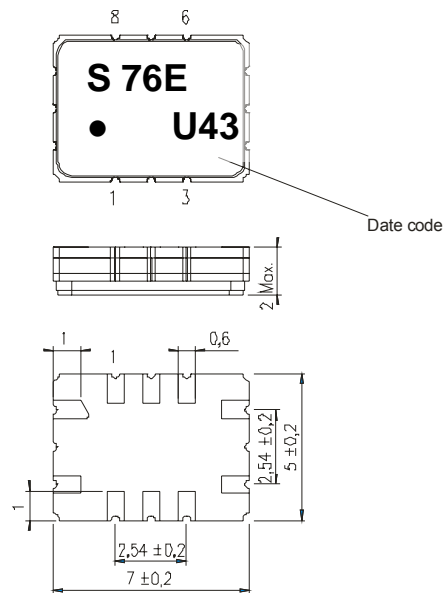

1	Ground
2	Ground
3	Ground
4	Output
5	Output
6	Ground
7	Ground
8	Ground
9	Input
10	Input

Date code: Year + week

U	2006
V	2007
W	2008
...	

200 Ohm Test circuit

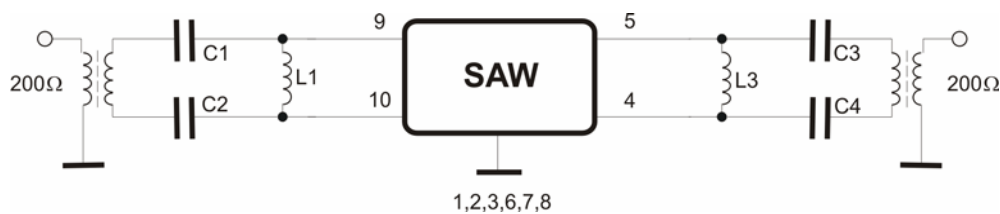

Tele Filter GmbH
 Potsdamer Straße 18
 D 14 513 TELTOW / Germany
 Tel: (+49) 3328 4784-0 / Fax: (+49) 3328 4784-30
 E-Mail: tft@telefilter.com

VI TELEFILTER reserves the right to make changes to the product(s) and/or information contained herein without notice. No liability is assumed as a result of their use or application. No rights under any patent accompany the sale of any such product(s) or information.

Stability characteristics

After the following tests the filter shall meet the whole specification:

1. Shock: 500g, 1 ms, half sine wave, 3 shocks each plane;
DIN IEC 68 T2 - 27
2. Vibration: 10 Hz to 500 Hz, 0,35 mm or 5 g respectively, 1 octave per min, 10 cycles per plan, 3 plans;
DIN IEC 68 T2 - 6
3. Change of temperature: -55 °C to 125°C / 30 min. each / 10 cycles
DIN IEC 68 part 2 – 14 Test N
4. Resistance to solder heat (reflow): reflow possible: three times max.;
for temperature conditions refer to the attached "Air reflow temperature conditions" on page 4;

This filter is RoHS compliant (2002/95/EG, 2005/618/EG)

Packing

Tape & Reel: IEC 286 – 3, with exception of value for N and minimum bending radius;
tape type II, embossed carrier tape with top cover tape on the upper side;

max. pieces of filters per reel:	3000
reel of empty components at start:	min. 300 mm
reel of empty components at start including leader:	min. 500 mm
trailer:	min. 300 mm

Tape (all dimensions in mm)

- W : 16,00 ± 0,3
- Po : 4,00 ± 0,1
- Do : 1,50 +0,1/-0
- E : 1,75 ± 0,1
- F : 7,50 ± 0,1
- G(min) : 0,60
- P2 : 2,00 ± 0,1
- P1 : 8,00 ± 0,1
- D1(min) : 1,50
- Ao : 5,50 ± 0,1
- Bo : 7,50 ± 0,1
- Ct : 13,5 ± 0,1

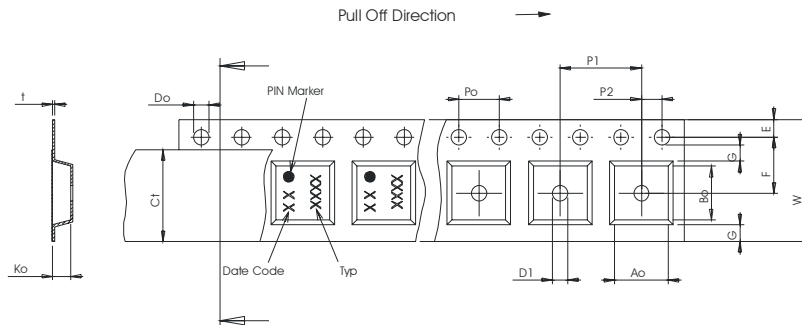

Reel (all dimensions in mm)

- A : 330
- W1 : 16,4 +2/-0
- W2(max) : 22,4
- N(min) : 50
- C : 13,0 +0,5/-0,2

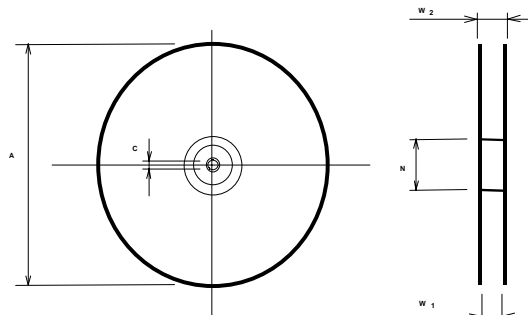

The minimum bending radius is 45 mm.

Tele Filter GmbH
Potsdamer Straße 18
D 14 513 TELTOW / Germany
Tel: (+49) 3328 4784-0 / Fax: (+49) 3328 4784-30
E-Mail: tft@telefilter.com

VI TELEFILTER reserves the right to make changes to the product(s) and/or information contained herein without notice. No liability is assumed as a result of their use or application. No rights under any patent accompany the sale of any such product(s) or information.

Air reflow temperature conditions

Conditions	Exposure
Average ramp-up rate (30°C to 217°C)	less than 3°C/second
> 100°C	between 300 and 600 seconds
> 150°C	between 240 and 500 seconds
> 217°C	between 30 and 150 seconds
Peak temperature	max. 260°C
Time within 5°C of actual peak temperature	between 10 and 30 seconds
Cool-down rate (Peak to 50°C)	less than 6°C/second
Time from 30°C to Peak temperature	no greater than 300 seconds

Chip-mount air reflow profile

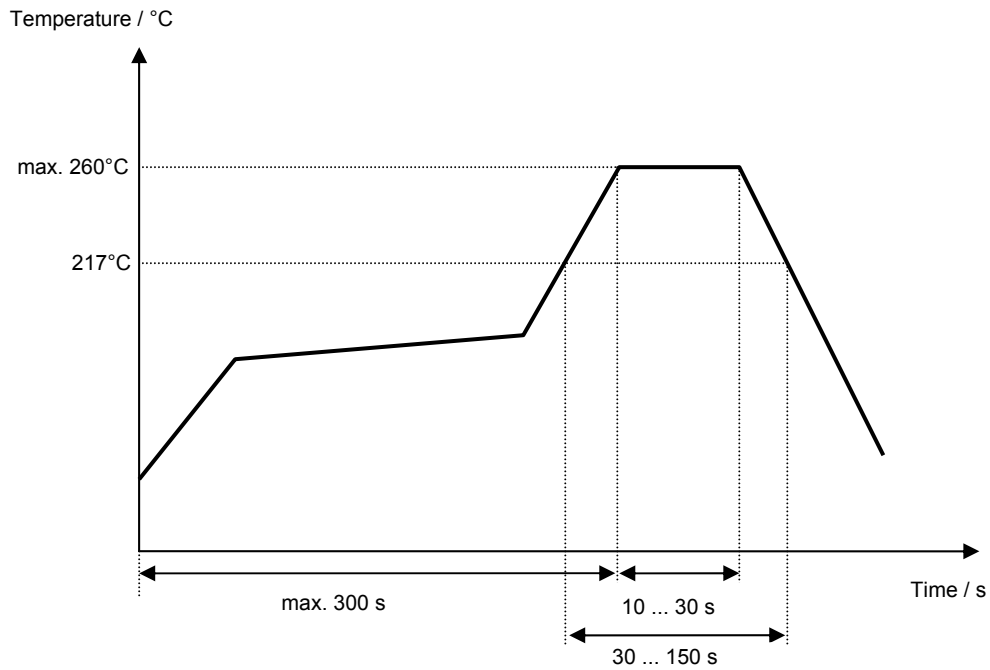

Tele Filter GmbH
Potsdamer Straße 18
D 14 513 TELTOW / Germany
Tel: (+49) 3328 4784-0 / Fax: (+49) 3328 4784-30
E-Mail: tft@telefilter.com

VI TELEFILTER reserves the right to make changes to the product(s) and/or information contained herein without notice. No liability is assumed as a result of their use or application. No rights under any patent accompany the sale of any such product(s) or information.

VI TELEFILTER**Filter specification****TFS 76E****5/5****History**

Version	Reason of Changes	Name	Date
1.0	- generation of development specification	Strehl	14.06.2005
1.1	- created filter specification - added terminating impedances - added typical values - added filter characteristics - changed construction and pin connection - added test circuit	Chilla	03.05.2006
1.2	- changed terminating impedances - changed remark - added temperature coefficient - changed construction and pin connection - changed test circuit	Chilla	25.10.2006

Tele Filter GmbH
Potsdamer Straße 18
D 14 513 TELTOW / Germany
Tel: (+49) 3328 4784-0 / Fax: (+49) 3328 4784-30
E-Mail: tft@telefilter.com

VI TELEFILTER reserves the right to make changes to the product(s) and/or information contained herein without notice. No liability is assumed as a result of their use or application. No rights under any patent accompany the sale of any such product(s) or information.