

VI TELEFILTER**Filter specification****TFS 44E****1/5****1. Measurement condition :**

Ambient temperature T_A : 23 °C
 Input power level: 0 dBm.
 Terminating impedances at f_C : for input: 50 Ω | 0 pF.
 for output: 50 Ω | 0 pF.

2. Characteristics :

Remark:

Reference level for the relative attenuation a_{rel} of the **TFS 44E** is the minimum of the pass band attenuation a_{min} . The minimum of the pass band attenuation a_{min} is defined as the insertion loss a_e . The centre frequency f_C is the arithmetic mean value of the upper and lower frequencies at the **20 dB** filter attenuation level relative to the insertion loss a_e . The nominal frequency f_N is fixed at **44 MHz** without tolerance. The temperature coefficient of frequency T_{c_f} is valid both for the reference frequency f_C and the frequency response of the filter. All specified parameters have to be reached in the operating temperature range (**OTR**) .

Data	typ. value	tolerance / limit
Insertion loss (Reference level) a_e	21 dB	max. 24 dB
Nominal frequency : f_N at temperature $T_O = 30^\circ\text{C}$	44,000 MHz	44 MHz
Centre frequency f_C at ambient temperature T_A (f_{CAT})	44,019 MHz	
Pass band (PB) at OTR : $0^\circ\text{C} \dots 60^\circ\text{C}$:		$f_N - 2,48 \text{ MHz} \dots f_N + 2,48 \text{ MHz}$
Amplitude ripple in PB (p-p) :	0,2 dB	max. 0,4 dB
Bandwidth at ambient temperature T_A (f_{CAT}) :		
0,4 dB	5,70 MHz	min. 5,16 MHz
1 dB	6,03 MHz	
3 dB	6,51 MHz	min. 6,20 MHz
10 dB	7,22 MHz	
20 dB	7,72 MHz	
30 dB	8,02 MHz	max. 8,30 MHz
40 dB	8,21 MHz	
Bandwidth at OTR : $0^\circ\text{C} \dots 60^\circ\text{C}$:		
0,4 dB - band width	5,50 MHz	min. 4,96 MHz
3 dB - band width	6,31 MHz	min. 6,00 MHz
30 dB - band width	8,22 MHz	max. 8,50 MHz
Relative attenuation a_{rel} at OTR : $0^\circ\text{C} \dots 60^\circ\text{C}$		
$f_N \dots f_N \pm 2,48 \text{ MHz}$	0,25 dB	max. 0,4 dB
$f_N \pm 2,48 \text{ MHz} \dots f_N \pm 3,0 \text{ MHz}$	2,5 dB	max. 3,0 dB
$f_N \pm 4,25 \text{ MHz} \dots f_N \pm 5 \text{ MHz}$	45 dB	min. 30 dB
$f_N \pm 5 \text{ MHz} \dots f_N \pm 26 \text{ MHz}$	45...55 dB	min. 40 dB
Group delay (mean value in PB):	1,50 μs	
Group delay ripple in PB (p-p):	35 ns	max. 90 ns
Phase ripple in PB (p-p):	2 °	
Temperature coefficient of frequency (T_{c_f})	-75 ppm/K	
Frequency deviation of f_C over temperature	$\Delta f_C(\text{Hz}) = T_{c_f}(\text{ppm/K}) \times (T - T_A) \times f_{CAT} (\text{MHz})$	
Operating temperature (OTR) :		$0^\circ\text{C} \dots + 60^\circ\text{C}$
Storage temperature range		$- 25^\circ\text{C} \dots + 85^\circ\text{C}$

Generated:**Dunzow W.****Checked/Approved:****Dr. Bert Wall**

VI TELEFILTER
 Potsdamer Straße 18
 D 14 513 TELTOW / Germany
 Tel: (+49) 3328 4784-0 / Fax: (+49) 3328 4784-30
 E-Mail: vt@telefilter.com

Vectron International, Inc.
 267 Lowell Road
 Hudson, NH 03051 / USA
 Tel: (603) 598-0070 Fax: (603) 598-0075
 E-Mail: vti@vtinh.com

VI TELEFILTER reserves the right to make changes to the product(s) and/or information contained herein without notice. No liability is assumed as a result of their use or application. No rights under any patent accompany the sale of any such product(s) or information.

VI TELEFILTER**Filter specification****TFS 44E****2/5****3. Construction and pin connection**

(all dimensions in mm)

pin grid 1,91 mm

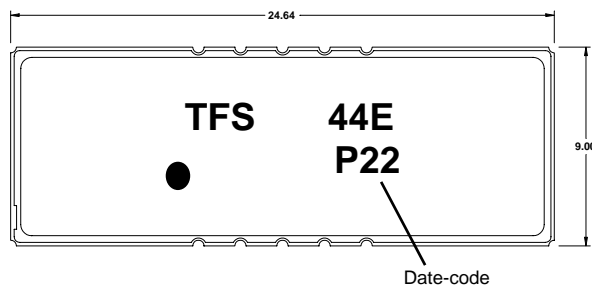

Date-code:	Year+week
M	2000
N	2001
P	2002
...	...

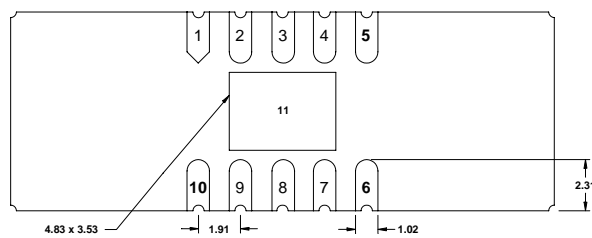
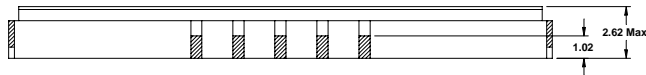

Pin 10	Input
Pin 1	Input RF Return
Pin 5	Output
Pin 6	Output RF Return
Pin 2-4, 7-9	Package Ground

4. 50 Ω matching networks (please refer to the application note for further details) :

For final test we use scheme 1.

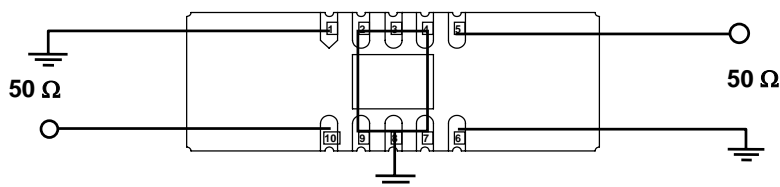
**Scheme 1.**

5. Stability characteristics :

After the following tests the filter shall meet the whole specification:

1. Shock: 500g, 18 ms, half sine wave, 3 shocks each plane;
DIN IEC 68 T2 - 27
2. Vibration: 10 Hz to 500 Hz, 0,35 mm or 5g respectively, 1 octave per min, 10 cycles per plan, 3 plans;
DIN IEC 68 T2 - 6
3. Change of temperature: -55 °C to 125°C / 30 min. each / 10 cycles
DIN IEC 68 part 2 – 14 Test N
4. Resistance to solder heat (reflow): reflow possible: twice max. ;
for temperature conditions, please refer to the attached "Air reflow temperature conditions" on page 4;

6. Packing :

Tape & Reel: DIN IEC 286 - 3, with exception of value for N and minimum bending radius;
tape type II, embossed carrier tape with top cover tape on the upper side;

max. pieces of filters per reel:	1000
reel of empty components at start:	min 300 mm
reel of empty components at start including leader:	min 500 mm
Trailer	min 300 mm

Tape (all dimensions in mm)

W	: 44 ± 0,3
Po	: 4 ± 0,1
Do	: 1,5 + 0,1
E	: 1,75 ± 0,1
So	: 40,4 ± 0,1
P2	: 2 ± 0,15
P1	: 16 ± 0,1
D1(min)	: 2,0
Ao	: 9,3 ± 0,1
Bo	: 24,9 ± 0,1
Ko	: 2,0 ± 0,1
t	: 0,35 ± 0,05
CT	: 38,0 ± 0,1

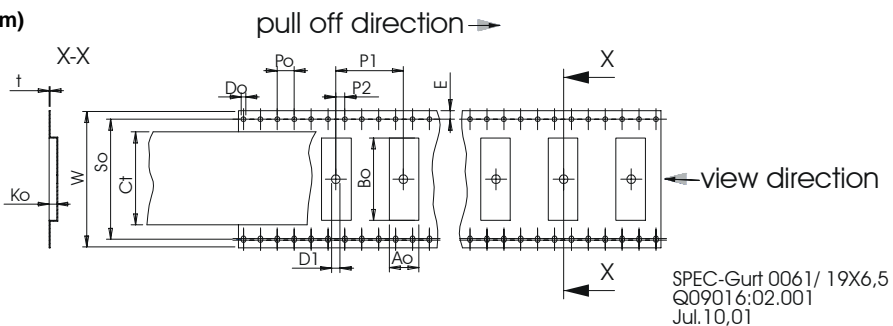

Reel (all dimensions in mm):

A	: 330
W1	: 44,4 + 2/-0
W2(max)	: 50,4
N(min)	: 100
C	: 13,0 +0,5 / -0,2

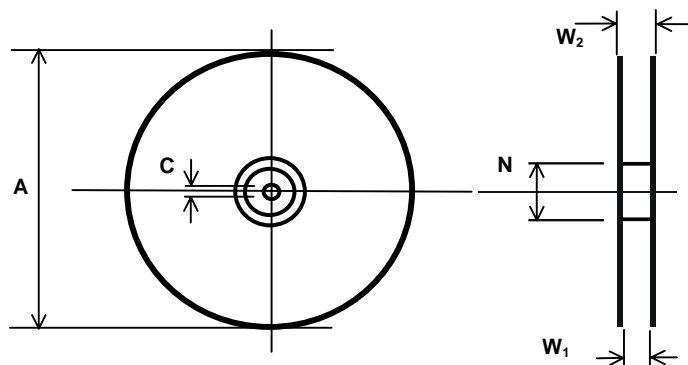

The minimum bending radius is 45 mm. The mounting surface of the filters faces the bottom side of the embossed carrier tape. The marking of the filters is able to read if the view is directed on the upper side of the carrier tape in the above shown direction.

VI TELEFILTER

Potsdamer Straße 18
D 14 513 TELTOW / Germany
Tel: (+49) 3328 4784-0 / Fax: (+49) 3328 4784-30
E-Mail: tft@telefilter.com

Vectron International, Inc.
267 Lowell Road
Hudson, NH 03051 / USA
Tel: (603) 598-0070 Fax: (603) 598-0075
E-Mail: vti@vtinh.com

VI TELEFILTER reserves the right to make changes to the product(s) and/or information contained herein without notice. No liability is assumed as a result of their use or application. No rights under any patent accompany the sale of any such product(s) or information.

6. Air reflow temperature conditions :

1st and 2nd air reflow profile

Name:	pre-heating periods	main-heating periods	peak temperature
Temperature:	150 °C - 170 °C	over 200 °C	255 °C ± 5 °C
Time:	60 sec. - 90 sec.	20 sec. - 25 sec.	

Chip-mount air reflow profile

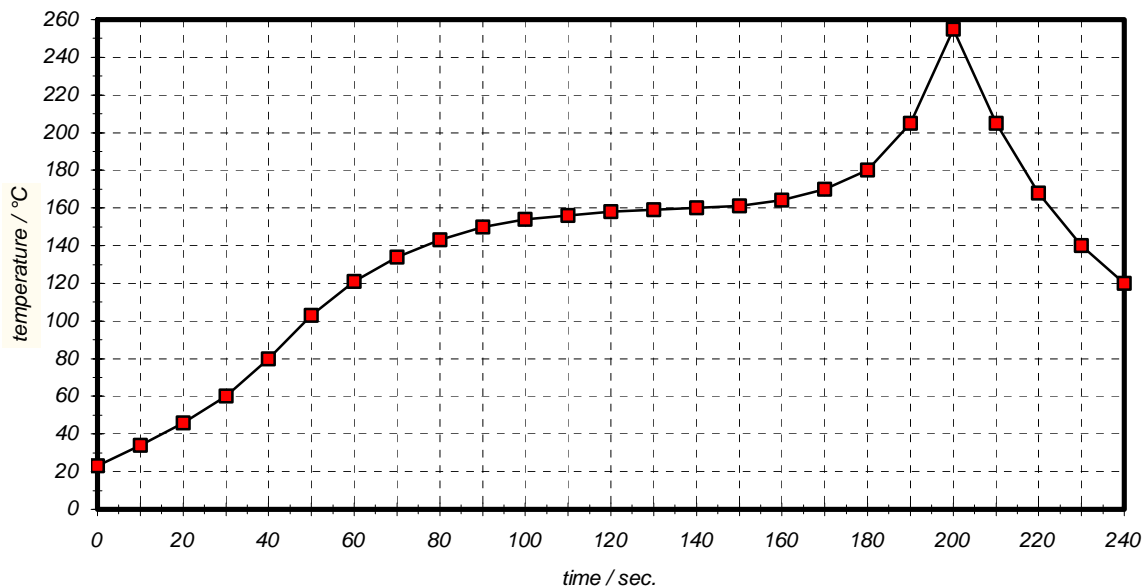

Table for temperature vs. time during the air reflow process

Tolerance of temperatures: ± 5 °C

time / sec.	temperature / °C	time / sec.	temperature / °C
0	23	140	160
10	34	150	161
20	46	160	164
30	60	170	170
40	80	180	180
50	103	190	205
60	121	195	230
70	134	200	255
80	143	205	230
90	150	210	205
100	154	215	180
110	156	220	165
120	158	230	140
130	159	240	120

VI TELEFILTER**Filter specification****TFS 44E****5/5**

7. History :

Version	Reason of Changes	Name	Date
1.0	- generate development specification according to customer requirements.	Dunzow W.	30.10.2001
1.1	- generate filter specification. - add 40 dB limit lines; - add typical values.	Dunzow W.	22.03.2002

VI TELEFILTER
Potsdamer Straße 18
D 14 513 TELTOW / Germany
Tel: (+49) 3328 4784-0 / Fax: (+49) 3328 4784-30
E-Mail: ftf@telefilter.com

Vectron International, Inc.
267 Lowell Road
Hudson, NH 03051 / USA
Tel: (603) 598-0070 Fax: (603) 598-0075
E-Mail: vti@vtinh.com

VI TELEFILTER reserves the right to make changes to the product(s) and/or information contained herein without notice. No liability is assumed as a result of their use or application. No rights under any patent accompany the sale of any such product(s) or information.