

Helping Customers Innovate, Improve & Grow

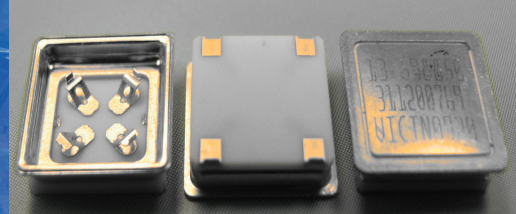
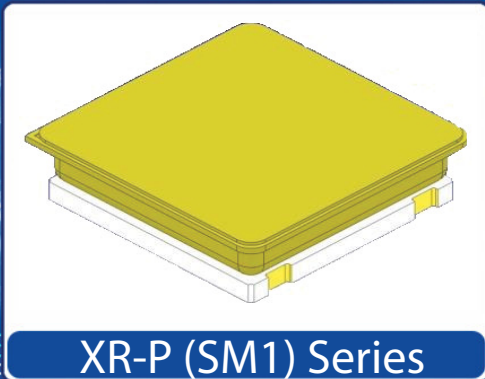

Description

Vectron International's XR-P (SM1 style) resistance weld crystals provide a precision, high reliability surface mount design in a rugged mount. These precision crystals offer excellent industry leading performance characteristics and tight stabilities in a wide range of frequencies (comparable to Vectron's XR-R AT-Cut HC35/TO-5 offerings). Low phase noise and low g-sensitivity options make this an ideal choice for Microwave, Satellite, Telemetry, Radar and Military Communication applications.

Features

- Robust 4 pt blank mount
- Surface Mount or Hybrid Wirebonded applications
- AT-Cut Fundamental and OT Modes
- Low Phase Noise, Low G-Sensitivity options
- Tight Stabilities and Tolerances, Excellent Aging
- Rugged Design for demanding environments
- Swept Quartz & Hi-Rel Screening Options Available
- High Temperature Options to +200°C

Applications

- Telecommunications
- Military & Defense
- Microwave
- Telemetry
- Ground and Satellite Communications
- Precision Oscillators (TCXO, VCXO, OCXO)
- Hybrid, Wirebondable Mount

Standard Physical Specifications

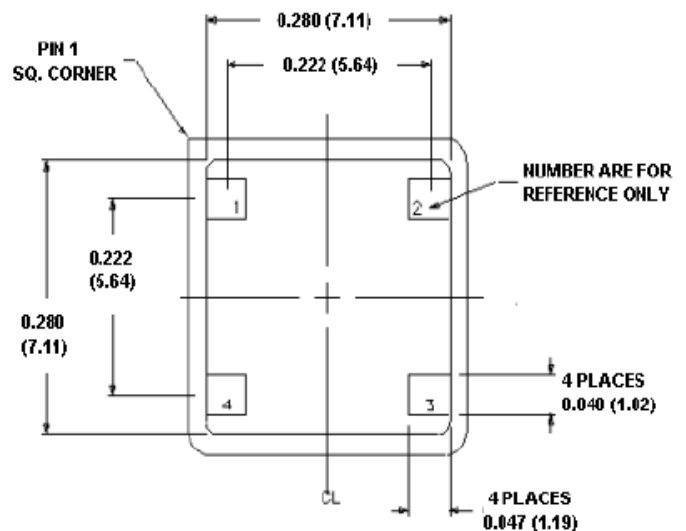
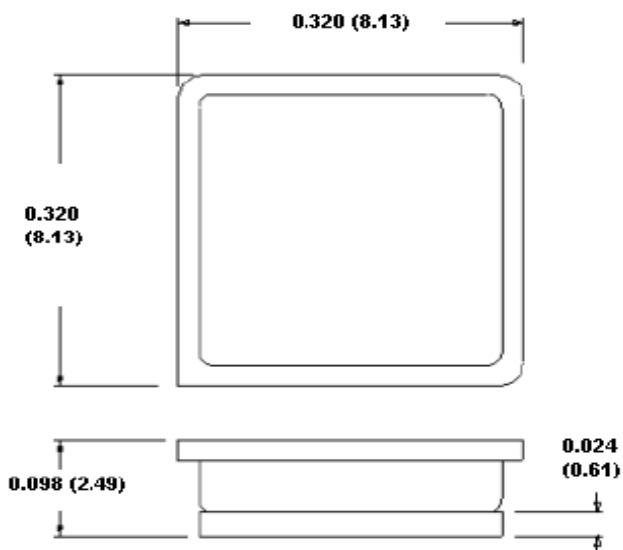

Typical Electrical Performance Characteristics

AT-CUT VARIETIES		
Performance Characteristic	Symbol	Typical Performance Specifications
Frequency Range	F_o	7 MHz to 225 MHz
Operating Temperature Range		-55°C to +125°C (high temperature up to +200°C available)
Frequency Stability over Operating Temp Range	F_T	+/- 5 ppm to +/- 50 ppm (mode, frequency and operating temp range dependent)
Frequency Calibration Tolerance +25°C	$F_R - F_L$	+/- 10 ppm typical (+/- 2 ppm available)
Equivalent Series Resistance	R (ESR)	10 ohms to 100 ohms (mode and frequency dependent)
Shunt Capacitance	C_o	2.5 pF - 4 pF typical
Motional Capacitance	C_1	0.1 fF - 30 fF (mode and frequency dependent)
Load Capacitance	C_L	series to 32 pF (customer specified load)
Drive Level	DL	100 uW (50 uW to 5 mW)
Aging per year after first 30 days		< 3 ppm (< 1ppm available)

PHASE NOISE @ 100 Hz OFFSET (dBc/Hz)		
Mode - Cut	Frequency Range	Phase Noise
Fundamental-AT	7 MHz -to 30 MHz	-80 to -115
3 rd OT - AT	17 MHz - 105 MHz	-80 to -135
5 th OT - AT	40 MHz - 175 MHz	-90 to -135
7 th OT - AT	70 MHz - 225 MHz	-80 to -110

Phase Noise performance is mode and frequency dependent

NOMINAL G-SENSITIVITY (4 pt. blank mount)	
Cut	G-SENSITIVITY
AT	1 X 10 ⁻⁹ /g (average attainable when specified)
<i>Results assume same frequency and mode when specified. Better results are available.</i>	

TYPICAL ESR & C ₁ BY MODE AND FREQUENCY RANGE			
Mode	Frequency Range (MHz)	*ESR Typical (ohms)	*C ₁ Typical (fF)
Fund.	7 - 35 MHz	25-360	5 - 25
3 rd	17 - 105 MHz	40	1 -2.5
5 th	40 - 175 MHz	75	0.70
7 th	70 - 225 MHz	120	0.35

**ESR and C₁ values are dependent upon the specified frequency and mode of vibration.*

EQUIVALENT CIRCUIT OF A CRYSTAL RESONATOR



Vectron International designs and manufactures SM1 surface mount crystals for a wide variety of commercial, hybrid and high reliability applications. *Our proven cleanroom finish processes yield excellent aging and low perturbations.*

We have tight controls over series resistance, motional capacitance, temperature characteristics and other parameters critical to your application. We primarily build to customer specifications but we've optimized designs on all frequencies that are commonly used in telecommunications.

Please feel free to contact us with your questions. We are here to assist you with selecting the best performing and most cost effective crystal for your application.

PART NUMBER ORDERING INFORMATION

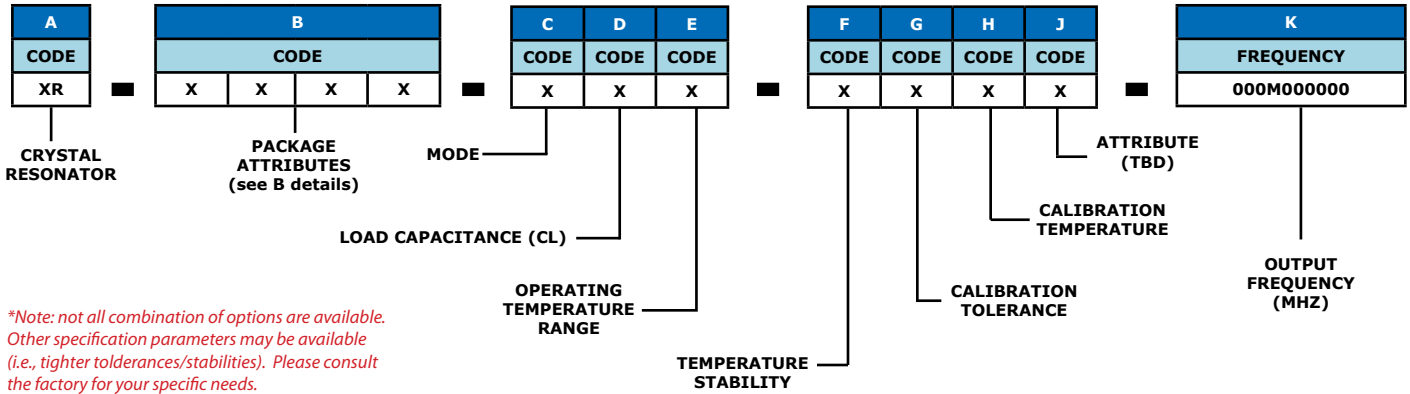

PART NUMBER CODES (attribute details)

B							
X		X		X		X	
CODE	PACKAGE TYPE	CODE	PACKAGE HEIGHT (A)	CODE	SEAL METHOD	CODE	LEAD STYLE
P	SM1	1	.098 (2.49)	1	RW	1	STANDARD

C		E		F		G		H		J		
CODE	MODE	CODE	OPERATING TEMPERATURE RANGE	CODE	FREQUENCY STABILITY OVER TEMPERATURE	CODE	FREQUENCY CALIBRATION TOLERANCE	CODE	FREQUENCY CALIBRATION TEMPERATURE	CODE	TBD	
1	Fund	A	-55°C to +85°C	A	+/- 5 ppm	A	+/- 5 ppm	A	+25°C	A	TBD	
3	3 rd OT	B	-55°C to +105°C	B	+/- 10 ppm	B	+/- 10 ppm	B	+50°C	B	TBD	
5	5 th OT	C	-55°C to +125°C	C	+/- 12 ppm	C	+/- 12 ppm	C	+55°C	C	TBD	
7	7 th OT	D	-40°C to +70°C	D	+/- 15 ppm	D	+/- 15 ppm	D	+60°C	D	TBD	
9	9 th OT	E	-40°C to +85°C	E	+/- 20 ppm	E	+/- 20 ppm	E	+65°C	E	TBD	
D		F	-40°C to +105°C	F	+/- 25 ppm	F	+/- 25 ppm	F	+70°C	F	TBD	
CODE	LOAD CAPACITANCE	G	-30°C to +80°C	G	+/- 30 ppm	G	+/- 30 ppm	G	+75°C	G	TBD	
S	Series	H	-30°C to +85°C	H	+/- 32 ppm	H	+/- 32 ppm	H	+80°C	H	TBD	
A	8 pF	J	-20°C to +70°C	J	+/- 40 ppm	J	+/- 40 ppm	J	+85°C	J	TBD	
B	10 pF	K	-10°C to +60°C	K	+/- 50 ppm	K	+/- 50 ppm	K	+90°C	K	TBD	
C	12 pF	M	-10°C to +75°C	M	+/- 60 ppm	M	+/- 60 ppm	M	+95°C	M	TBD	
D	15 pF	N	-5°C to +70°C	N	+/- 75 ppm	N	+/- 75 ppm	N	+100°C	N	TBD	
E	18 pF	P	0°C to +50°C	P	+/- 80 ppm	P	+/- 80 ppm	P	+105°C	P	TBD	
F	20 pF	R	0°C to +55°C	R	+/- 90 ppm	R	+/- 90 ppm	R	+110°C	R	TBD	
G	25 pF	S	0°C to +60°C	S	+/- 100 ppm	S	+/- 100 ppm	S	+115°C	S	TBD	
H	30 pF	T	0°C to +70°C	T	+/- 130 ppm	T	+/- 130 ppm	T	+120°C	T	TBD	
J	32 pF	U	0°C to +85°C	U	+/- 150 ppm	U	+/- 150 ppm	U	+125°C	U	TBD	
K	35 pF	V	+10°C to +40°C	V	+/- 200 ppm	V	+/- 200 ppm	CALIBRATION TEMPERATURE IS ALWAYS +25°C UNLESS OTHERWISE SPECIFIED	Z	Custom	Z	Custom
M	40 pF	W	-10°C to +70°C	W	+/- 250 ppm	W	+/- 250 ppm					
N	45 pF	Y	-55°C to +185°C	Y	+/- 300 ppm	Y	+/- 300 ppm					
P	50 pF	Z	-20°C to +180°C	Z	Custom	Z	Custom					
R	55 pF	1	0°C to +150°C									
S	60 pF	2	0°C to +200°C									
T	65 pF	9	Custom									
U	70 pF											
V	75 pF											
W	80 pF											
Y	90 pF											
Z	Custom											

Typical Environmental Specifications

TEST DESCRIPTION	SPECIFICATION REFERENCE
SHOCK	MIL-STD-202, Method 213, Cond. C (100g, 6ms, Half-Sine)
VIBRATION	MIL-STD-202, Method 201/204 (Random-Sine, 20g)
TEMPERATURE CYCLE	MIL-STD-883, Method 1010 (-55°C/+125°C), 10 cycles
THERMAL SHOCK	MIL-STD-202, Method 107
MOISTURE RESISTANCE	MIL-STD-202, Method 106
SALT ATMOSPHERE	MIL-STD-202, Method 101
ACCELERATION	MIL-STD-883, Method 2001, Condition A (5,000g)
SOLDERABILITY	MIL-STD-202, Method 208 (ANSI-EIA-J-STD-002)
TERMINAL STRENGTH	MIL-STD-202, Method 211 (2lbs)
PIND	MIL-STD-883, Method 2020, Condition A or B (20g, 10g)
FINE LEAK	MIL-STD-202, Method 112, Condition C-IIIc (1x10 ⁻⁸ atm/cc ²)
GROSS LEAK	MIL-STD-202, Method 112, Condition D
RESISTANCE TO SOLVENTS	MIL-STD-202, Method 215
RESISTANCE TO SOLDERING HEAT	MIL-STD-202, Method 210, Condition K
HIGH TEMPERATURE STORAGE	MIL-STD-883, Method 1008, Condition C (+125°C, 168 hours)
LOW TEMPERATURE STORAGE	MIL-PRF-3098

Vectron is uniquely equipped to handle all of your special test requirements. All environmental and qualification related tests are performed in house. We've demonstrated compliance and the ability to test to the requirements of all governing industry and military crystal specifications (past and present).

Some of which include;

- MIL-PRF-3098
- MIL-C-49468
- MIL-C-3098
- TOR-2006 (8583)-5236
- EEE-INST-002
- MIL-PRF-55310
- MIL-STD-202
- MIL-STD-883
- OTHERS

Additional Technical Information

Diagrams of Series and Parallel Resonant Circuits

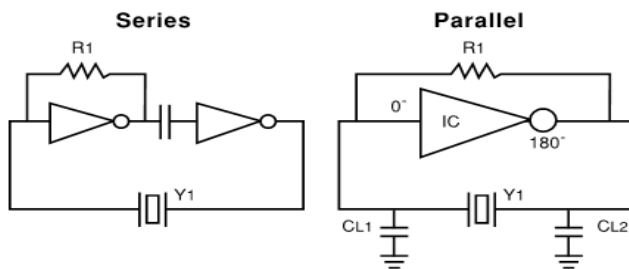

Typical Wave Solder Reflow Profile (Sn-Pb)

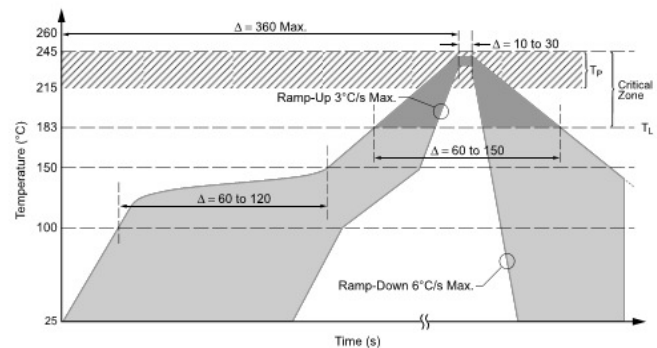

For Additional Information, Please Contact

USA:

Vectron International
4914 Gray Road
Cincinnati, OH 45232
Tel: 1.513.542.5555
Fax: 1.513.542.5146
Tel: 1.888.328.7661

Europe:

Vectron International
Landstrasse, D-74924
Neckarbischofsheim, Germany
Tel: +49 (0) 3328.4784.17
Fax: +49 (0) 3328.4784.30

Asia:

Vectron International
1F-2F, No 8 Workshop, No 308 Fenju Road
WaiGaoQiao Free Trade Zone
Pudong, Shanghai, China 200131
Tel: 86.21.5048.0777
Fax: 86.21.5048.1881

Disclaimer

Vectron International reserves the right to make changes to the product(s) and or information contained herein without notice. No liability is assumed as a result of their use or application. No rights under any patent accompany the sale of any such product(s) or information.

Rev: 12/2009